



QUICKJUMP / QUICKJUMP XL FREE FALL DEVICE

Operator Manual

Models: QJ-150-12A / QJXL150-20A



NOTE TO INSTALLERS

Always Read Instructions Before Use

Leave this Operator Manual attached to the QUICKjump Free Fall Device. The Operator Manual contains information relating to the proper use of the QUICKjump Free Fall Device and includes all product registration and warranty information. This document may only be removed by the end user. Ensure that this Operator Manual is readily available to operators at all times.

Head Rush Technologies QUICKjump Free Fall Device Manual
P/N 02070002906

Head Rush Technologies products are covered by a number of patents, including **U.S. Patents** 8,490,751; 8,851,235; 9,016,435; 8,851,235 and D654,412 & corresponding patents/applications in the USA and in other countries worldwide.

QUICK
jump

TABLE OF CONTENTS

SAFETY INFORMATION	6
Symbols Used in this Manual	6
WARRANTY CONDITIONS	7
Customer Responsibility	7
CERTIFICATION	9
Standards	9
DESCRIPTION	10
SPECIFICATIONS	11
Location of Specification Labels	13
QUICKJUMP FREE FALL DEVICE PARTS	14
UNPACKING	15
Precautions	15
Unpacking the QUICKjump Free Fall Device	15
Storage	16
INSTALLATION	17
Precautions	17
Standards	17
Anchor Points	17
Harness	18
Secondary Connectors	18
Selecting a Location	18
Outdoor Installations	19
Mounting	19
Mounting Points	20
Single Point Mounting	20
Double Point Mounting	21
OPERATION	23
Operator Training	23
Operator/User Instruction	23
Harness	25
Carabiner Use	25
Operation	26
Webbing Retraction Procedure	26
Webbing Retraction Tips	27

INSPECTION & MAINTENANCE	28
Annual Recertification	28
Scheduled Maintenance and Inspections	28
<i>Safety Precautions</i>	29
Daily Inspection	29
<i>Inspection Procedure</i>	29
<i>RipCord Inspection</i>	31
<i>Webbing Wear</i>	31
Weekly Inspection	36
Six Month Inspection	36
<i>Inspection Procedure</i>	36
<i>Webbing Inspection</i>	37
Nozzle Replacement	38
Webbing Line Replacement	40
<i>Safety Precautions</i>	40
<i>Webbing Line Replacement Procedure</i>	40
Replacement Parts	42
Troubleshooting	43
Transportation	43
MANUFACTURER'S DETAILS	44
Address	44
Contact Details	44



IMPORTANT SAFETY NOTICE

Recreational Descent Is A Dangerous Activity

Read Before Installation & Operation

Failure by the operator to heed any and all instructions, warnings and cautions for the correct installation, operation, care and maintenance of the QUICKjump Free Fall Device may result in serious injury and/or death.

QUICKjump Free Fall Device Models QJ150-12A, QJXL150-20A and associated equipment are designed and specified for use as rapid descent devices.



NOT SUITABLE FOR CLIMBING

The QUICKjump Free Fall Device is not suitable for use as a belay device for climbing nor for use as personal protective equipment against a fall from height. Because of the large initial free fall and the rapid descent rate, this device is unsafe for any use other than the intended use stated above.

Use of the QUICKjump Free Fall Device for any purposes other than those intended by the manufacturer are not permitted and may result in serious injury and/or death.

Owners and operators of the QUICKjump Free Fall Device are responsible for the safety and supervision of any person using the QUICKjump Free Fall Device and are required to ensure that proper installation and operation procedures are followed at all times. Proper installation requires careful design and planning using QUICKjump and non-QUICKjump components. Owners and operators are required by the Manufacturer to read, understand, and follow all instructions in this Operator Manual regarding the correct installation and operation of the QUICKjump Free Fall Device prior to any use. Owners and operators are encouraged to seek the advice of their installer or a qualified engineering professional regarding the instructions in this Manual.

These instructions must be made readily available to the operators and users at all times. Prior to installation and use of the device, all owners and operators must have read and shown to have understood all instructions, labels, markings, and safety information pertaining to the installation, operation, care, and maintenance of the QUICKjump Free Fall Device system, its component parts, and all associated hardware. Failure to do so can result in death, serious injury and equipment damage.

Health and Safety

Owners and operators must abide by all Standards, International, Federal, State and Provincial laws, and any specific health and safety regulations pertaining to the installation and use of this product.

Site Rescue Plan

Owners and operators must have devised an emergency rescue plan for any rider in distress at all sites operating QUICKjump Free Fall Devices. Operators must inform Users of the QUICKjump Free Fall Device of the procedure for rescuing a rider in distress prior to riding.

SAFETY INFORMATION

Symbols Used in this Manual

The following safety symbols are used throughout this manual to highlight potential dangers. One or more precautions may be associated with practices and procedures described within this manual. Failure to adhere to any precautions highlighted can result in death, serious injury, and equipment damage.

Ensure that the owner/operator reads and understands all safety procedures related to the working environment and the task they are undertaking.



DANGER

Indicates a hazardous situation exists that, if not avoided, will result in serious injury or death.



WARNING

Indicates a potentially hazardous situation that, if not avoided, could result in serious injury or death.



CAUTION

Indicates a potentially hazardous situation that, if not avoided, may result in injury or equipment damage.



NOTE

Indicates an action that must be taken to ensure personal safety and prevent damage to property or equipment.



CARE FOR THE ENVIRONMENT

Take care to minimize impact on the environment when carrying out this procedure.

WARRANTY CONDITIONS

This QUICKjump Free Fall Device is warranted against factory defects in materials and workmanship (excluding "Replacement Parts" – see below) for a period of two (2) years from date of purchase. This warranty applies only to the original purchaser, and is contingent upon the owner/operator maintaining and using the device in accordance with Manufacturer's instructions, including the requirement to continue to maintain annual re-certification as described in the Operator's Instruction Manual. This Warranty is in lieu of all other warranties, express or implied.

The sole remedy for breach of this warranty, or for any claim in negligence or strict liability in tort, is the repair or replacement of any defective parts by Head Rush Technologies. Upon notice in writing, Head Rush Technologies will promptly repair or replace all defective items. Head Rush Technologies reserves the right to have any defective equipment returned to its plant, transportation pre-paid, for inspection before making a repair or replacement.

This Warranty is null and void if parts other than genuine parts are used, or if any modifications or services have been performed on the device by anyone other than an authorized Head Rush Technologies servicing agent. This warranty does not cover any damages resulting from abuse to the device, damage in transit, or any other damage beyond the control of Head Rush Technologies. Head Rush Technologies makes no warranties in respect to trade accessories or component parts which are not made by Head Rush Technologies. Head Rush Technologies expressly excludes from this Warranty the replacement of "Replacement Parts", which include the nozzle, the webbing line kit, carabiner and/or any other accessories supplied with the product.

No person, agent or Distributor is authorized to give any warranty, other than the one herein expressed, on behalf of Head Rush Technologies, or to assume for it any liability pertaining to such products. Head Rush Technologies expressly disclaims any implied guarantee of merchantability, or claim as to whether the device is suited for a particular purpose. Purchaser agrees that Head Rush Technologies shall not be held liable to Purchaser/Operator for damages of any kind, including but not limited to, lost or projected profits, equipment down time, or any losses considered to be caused by non-operation or servicing/re-certification down time of the equipment.

Customer Responsibility

The following items are considered to be the responsibility of the Customer and are therefore not reimbursable under the terms of the warranty.

- Routine maintenance and inspection.
- Normal replacement of service items.
- Replacements required because of abuse, misuse or improper operational habits of the operator.

-
- Wearing parts such as nozzle, webbing line and carabiner.
 - Normal deterioration due to use and exposure.

This warranty is subject to the following of the requirements of the Operator Manual supplied, Manufacturer's instructions, and the advice given by Head Rush Technologies service technicians.

CERTIFICATION

Standards



NOTE

If the QUICKjump Free Fall Device is resold outside of the country of destination, the reseller must provide instructions for use, service, maintenance and repair in the language of the country of use.

The QUICKjump Free Fall Device is used as a component of an amusement ride only in combination with other components. It shall not be deemed suitable for use until it is ensured that the entire system complies with the requirements of appropriate regional, state, and federal directives/standards.

QUICKjump Free Fall Device complies with the following prevailing Safety regulations:

- ASTM F2291-11: Standard Practice for Design of Amusement Rides and Devices

DESCRIPTION

The QUICKjump Free Fall Device is a descent device designed specifically for use as a component of an amusement ride. Three models are available:

- QJ150-12A QUICKjump Free Fall Device
- QJXL150-20A QUICKjump XL Free Fall Device

The design of the QUICKjump Free Fall Device permits simple installation and removal and incorporates an advanced self-regulating brake system and automatic webbing line retraction. The patented braking mechanism offers riders an initial free fall followed by a consistent descent with a minimal variation in descent rate of both children and adults. There are no wearing parts in the brake mechanism, ensuring reliability remains high while maintenance and operating costs are kept to a minimum.

The RipCord accessory for QUICKjump extends the free fall feeling and is optional on QUICKjump and QUICKjump XL devices. The length of the RipCord necessarily changes the proper installation height, and RipCord webbings are NOT interchangeable between models. Refer to the full specifications based on your device model and RipCord length for proper installation details.

To protect the longevity of the QUICKjump Free Fall Device, installation, care and use of the QUICKjump Free Fall Device must be carried out in accordance with the instructions in this manual.

SPECIFICATIONS

QUICKjump

MODEL	QJ150-12A QUICKjump Free Fall Device	
DIMENSIONS	80 x 320 x 216 mm (15 x 12.6 x 8.5 in)	
NET WEIGHT	19.75 kg (44 lbs)	
MATERIALS	CASING	Aluminum Alloy
	INTERNAL PARTS	Zinc Plated Steel Stainless Steel
	NOZZLE	Modified Acetal plastic
	NOZZLE INSERT	304 Stainless Steel
	WEBBING LINE	20.8 mm Nylon Spectra webbing
MINIMUM DISTANCE NOZZLE TO PLATFORM	1.8 m (6 ft)	
MAXIMUM DISTANCE NOZZLE TO PLATFORM	2.1 m (7 ft)	
MIN. RIDER WEIGHT	20 kg (44 lbs)	
MAX. RIDER WEIGHT	130 kg (285 lbs)	
MIN. OPERATING TEMPERATURE	-10° C (14° F)	
MAX. OPERATING TEMPERATURE	40° C (104° F)	
MIN. STORED TEMPERATURE	-20° C (-4° F)	
MAX. STORED TEMPERATURE	60° C (140° F)	

NO RIPCORD

MINIMUM MOUNTING HEIGHT* 8 m (26 ft)

MAXIMUM MOUNTING HEIGHT* 12.5 m (41 ft)

0.8 M LOW MOUNT RIPCORD (BLUE)

MINIMUM MOUNTING HEIGHT* 5.3 m (17.4 ft)

MAXIMUM MOUNTING HEIGHT* 8 m (26 ft)

1.5 M RIPCORD (LIME)

MINIMUM MOUNTING HEIGHT* 9.5 m (31 ft)

MAXIMUM MOUNTING HEIGHT* 14 m (46 ft)

* Mounting heights are from nozzle to landing zone and may vary with the addition of authorized QUICKjump accessories.

QUICKjump XL

MODEL	QJXL150-20A QUICKjump XL Free Fall Device	
DIMENSIONS	80 x 320 x 216 mm (15 x 12.6 x 8.5 in)	
NET WEIGHT	20.8 kg (46 lbs)	
MATERIALS	CASING	Aluminum Alloy
	INTERNAL PARTS	Zinc Plated Steel Stainless Steel
	NOZZLE	Modified Acetal plastic
	NOZZLE INSERT	304 Stainless Steel
	WEBBING LINE	20.8 mm Nylon/Spec- tra/Technora webbing
MINIMUM DISTANCE NOZZLE TO PLATFORM	1.8 m (6 ft)	
MAXIMUM DISTANCE NOZZLE TO PLATFORM	2.1 m (7 ft)	
MIN. RIDER WEIGHT	20 kg (44 lbs)	
MAX. RIDER WEIGHT	130 kg (285 lbs)	
MIN. OPERATING TEMPERATURE	-10° C (14° F)	
MAX. OPERATING TEMPERATURE	40° C (104° F)	
MIN. STORED TEMPERATURE	-20° C (-4° F)	
MAX. STORED TEMPERATURE	60° C (140° F)	
NO RIPCORD		
MINIMUM MOUNTING HEIGHT*	10 m (33 ft)	
MAXIMUM MOUNTING HEIGHT*	20 m (65.5 ft)	
1.5 M RIPCORD (LIME)		
MINIMUM MOUNTING HEIGHT*	12.5 m (41 ft)	
MAXIMUM MOUNTING HEIGHT*	21.8 m (71.5 ft)	
3 M RIPCORD (ORANGE)		
MINIMUM MOUNTING HEIGHT*	14.2 m (46.6 ft)	
MAXIMUM MOUNTING HEIGHT*	23 m (75 ft)	

* Mounting heights are from nozzle to landing zone and may vary with the addition of authorized QUICKjump accessories.

Location of Specification Labels

INFORMATION LABEL

CAUTION

Not suitable for climbing. Biostructural research is a long-term activity.

Direction of rotation of the QUICK Jump Free Fall Device is specified for the safety of the user. The user must ensure that the device is always used in the direction of rotation specified in the user manual. The user must ensure that the device is always used in the direction of rotation specified in the user manual. The user must ensure that the device is always used in the direction of rotation specified in the user manual.

WARNING

Always use the device in accordance with the instructions for use. The user must ensure that the device is always used in the direction of rotation specified in the user manual. The user must ensure that the device is always used in the direction of rotation specified in the user manual. The user must ensure that the device is always used in the direction of rotation specified in the user manual.

NOTICE

The QUICK Jump Free Fall Device is not to be used for climbing. The user must ensure that the device is always used in the direction of rotation specified in the user manual. The user must ensure that the device is always used in the direction of rotation specified in the user manual. The user must ensure that the device is always used in the direction of rotation specified in the user manual.

SERIAL NUMBER
QJ150-12A SN0000000
QJXL150-20A SN0000000



SPECIFICATION LABEL

MODEL: QJ150-12A

RATED WORKING CAPACITY:
1h to 130 kg (15 to 285 lbs)

DEVICE WEIGHT:
13.75 kg (30 lbs)

MAXIMUM DESCENT LOAD:
130 kg (285 lbs)

MAXIMUM DESCENT HEIGHT:
12.5 m (41 ft)

NOTE: maximum descent height may vary with the addition of Authorized QUICK Jump Accessories.

MINIMUM DESCENT HEIGHT:
8.0 m (26 ft)

NOTE: minimum descent height may vary with the addition of Authorized QUICK Jump Accessories.

HEAD RUSH TECHNOLOGIES:
1825 2nd Street
Bozler, Colorado 80101, USA
www.headrushtechnologies.com

USA, CAN, UK AND OVERSEAS FACILITY AND 0 WORLDWIDE

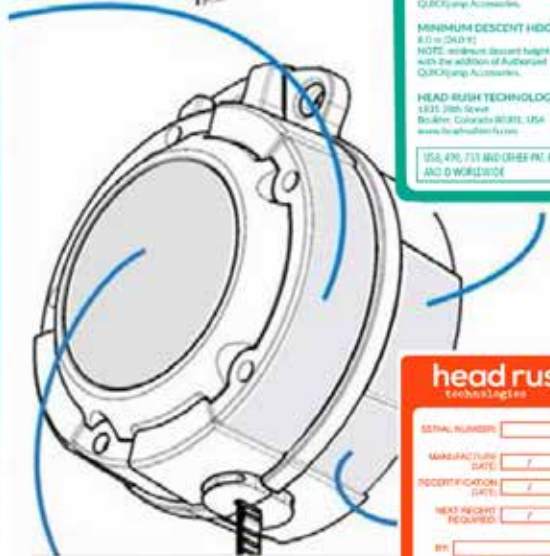

head rush
technologies

SERIAL NUMBER:

MANUFACTURE DATE:

RECONFIGURATION DATE:

NEXT REIGHT REQUIRED:

BY:

CERTIFICATION LABEL

QUICK jump

FREE FALL DEVICE

CAUTION

NOT SUITABLE FOR CLIMBING

COVER LABEL (Both Sides)

QUICKJUMP FREE FALL DEVICE PARTS

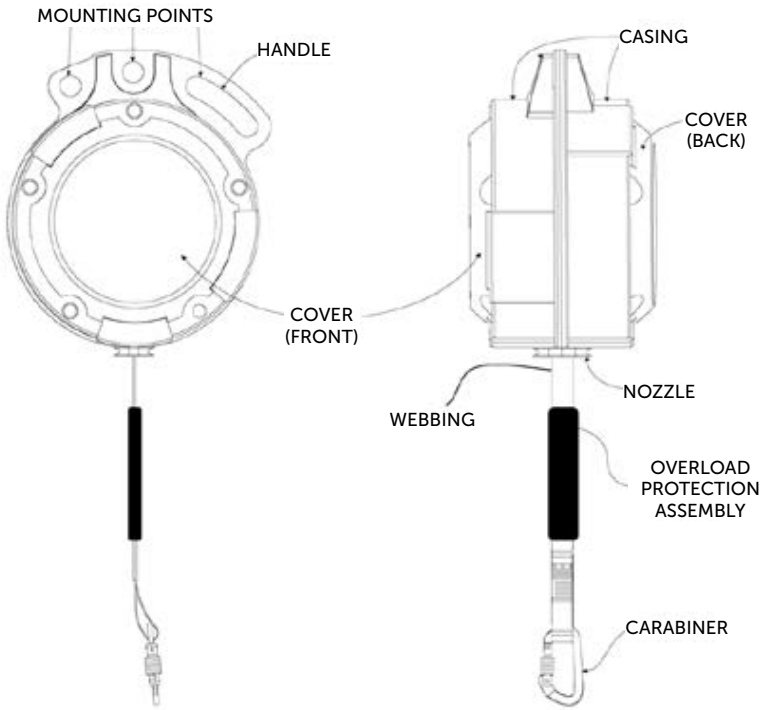

RipCord webbings are NOT interchangeable between the QUICKjump and QUICKjump XL Devices. Furthermore, the RipCord webbings are NOT designed or intended for use in any other device. These webbings have been specifically engineered for safe use in only the QUICKjump line of devices. Both devices can utilize a 1.5 m RipCord but the webbings are different as indicated by the handle color and color of the main webbing line. Installation of the wrong webbing in the wrong device can result in improper operation and potentially hazardous or dangerous fall conditions. Riders MUST meet the operational and safety guidelines set forth in your Operators Manual. Please double check and verify the safety limits set forth in the Operator Manual before live operation.

The RipCord webbing is a proprietary auxillary webbing for the QUICKjump family of devices only. These webbings are NOT COMPATIBLE with the zipSTOP Zip Line Brake, TRUBLUE Auto Belay or any other devices. The RipCord is not designed for other uses, and RipCord is the ONLY safe and approved way to extend the free fall distance of the QUICKjump device. Any RipCord that is exposed and no longer sealed should be taken out of service immediately. This should not be confused with the OPA section that includes a zipper for daily inspection of the OPA.

UNPACKING

Precautions



LEAVE THIS OPERATOR MANUAL ATTACHED TO THE QUICK-JUMP FREE FALL DEVICE UNTIL INSTALLATION IS COMPLETE. CAN ONLY BE REMOVED BY END OWNER/OPERATOR

The Operator Manual contains information relating to the proper and correct use of the QUICKjump Free Fall Device and includes all product registration and warranty information. The Operator Manual document may only be removed by the end operator. Ensure this manual is readily available to QUICKjump Free Fall Device riders at all times.



DO NOT DISPOSE OF PACKAGING

The cardboard box and internal packaging are required for the return of the QUICKjump Free Fall Device for the annual rectification inspection. Please keep packaging in a safe place until required.

Receipt of the QUICKjump Free Fall Device

The QUICKjump Free Fall Device is packaged in a recycled cardboard box and contains:

- 1 x QUICKjump Free Fall Device (model will vary depending on the specifics of your order):
 - QJ150-12A – QUICKjump without a RipCord
 - QJ150-12A – QUICKjump with 0.8m Low Mount RipCord
 - QJ150-12A – QUICKjump with 1.5m RipCord
 - QJXL150-20A – QUICKjump XL
 - QJXL150-20A – QUICKjump with 1.5m RipCord
 - QJXL150-20A – QUICKjump with 3m RipCord
- 1 x Carabiner
- 1 x Operator Manual

The Free Fall Device is shipped with the webbing line and carabiner attached and does not require any further assembly.

Unpacking the QUICKjump Free Fall Device

To unpack the QUICKjump Free Fall Device:

1. Upon receipt of QUICKjump Free Fall Device, inspect for signs of shipping damage or contamination. If QUICKjump Free Fall Device shows any signs of damage or mishandling contact your Head Rush Technologies distributor.

2. Check all labels affixed to QUICKjump Free Fall Device are present and legible.

head rush
technologies

SERIAL NUMBER:

MANUFACTURE DATE: / /

RECERTIFICATION DATE: / /

NEXT RECER REQUIRED: / /

BY:

LABEL P/N:00070002401

Do not use the QUICKjump Free Fall Device after date shown here

3. Check the Certification Label for the 'Next Recertification Required' date. If the date shown has passed or the label is missing or illegible the QUICK-jump Free Fall Device must not be put into service.
4. Register your QUICKjump Free Fall Device online at www.headrushtech.com/registration



PRODUCT REGISTRATION MUST BE COMPLETED

The Product Registration must be completed by registering online at headrushtech.com/registration. This is critical for receiving product notifications and up-to-date information for the safe use of the QUICKjump Free Fall Device.

5. Read the Operator Manual and familiarize yourself with all aspects of installation, operation, care and maintenance.

Storage

If the QUICKjump Free Fall Device is to be left unused for longer than two weeks, ensure the unit is clean and dry and webbing line is fully retracted into the unit.

When returning the QUICKjump Free Fall Device to duty after an extended period of inactivity always carry out a full inspection and operational check.



DO NOT STORE IN WET CONDITION

After exposure to water or damp conditions thoroughly clean and dry the QUICKjump Free Fall Device. Ensure the QUICKjump Free Fall Device is not left with a wet webbing line retracted inside the casing.

Always store in a clean and dry environment.

INSTALLATION

Precautions



ALWAYS USE DESIGNATED MOUNTING POINTS

Never install the QUICKjump Free Fall Device using any part of the device apart from the designated mounting points. Incorrect mounting can result in serious injury or death.



HARD IMPACTS MAY RESULT IN STRUCTURAL DAMAGE

Dropping of, or hard impacts to, the QUICKjump Free Fall Device can result in serious damage to mounting points and internal parts and may compromise safety of operation. If the QUICKjump Free Fall Device is subjected to a hard impact, remove it from duty and return to the service agent for inspection.



HEAVY ITEM - 20 KG

Take care when lifting the QUICKjump Free Fall Device. Take care not to drop the device as this may result in serious injury or equipment damage.



DO NOT MOUNT FULLY RIGID

QUICKjump device should always be hung vertically, not rigidly mounted. A fully rigid mount will result in excessive/premature webbing wear.

Standards

Prior to installation, all Operators must be familiar with the requirements of all relevant Standards for anchor points, hardware and equipment used with the QUICKjump Free Fall Device.

ANCHOR POINTS

All anchor points and connectors used with the QUICKjump Free Fall Device must conform to any local, regional, federal and state requirements for such devices.

Minimum requirements for anchor points must conform to the requirements of:

- EN 12572 - Climbing wall anchor points.
- EN 795 - Anchor Devices.

The location and anchor points for the QUICKjump Free Fall Device **MUST** comply with the following:

- Minimum load capacity of the anchor point(s): 10 kN (2248 lbs) in expected directions of application.
- Anchor points are not to be used by other devices or as attachments for hardware not associated with the QUICKjump Free Fall Device installation.

- Anchor points should be of a suitable size and type to correctly install any mounting hardware.

HARNESSES

All harnesses used in conjunction with the QUICKjump Free Fall Device must comply with the following applicable standards:

- EN 361 - Personal protective equipment for prevention of falls from a height – Full body harness
- EN 813 - Personal protective equipment for prevention of falls from a height – Sit harness.
- EN 12277 - Type A. Full Body Harness
- EN 12277 - Type B. Small Full Body Harness
- EN 12277 - Type C. Sit Harness

Harnesses must be of the correct size and fitment and be in serviceable condition.

SECONDARY CONNECTORS

All secondary connectors and hardware used in the installation of the QUICKjump Free Fall Device must conform to the requirements of:

- EN 362 - Types of connectors for personal protection.
- EN 12275 - Types of connectors for mountaineering.

All connectors, hooks, D-rings and shackles used to mount the QUICKjump Free Fall Device must meet a minimum breaking load of 10kN (2248 lbs) and be of compatible size, shape and strength for the mounting point to which they are attached.

SELECTING A LOCATION

The QUICKjump Free Fall Device is to be mounted at the top of the descent route with the nozzle and webbing line pointed down.

When selecting a location to mount the QUICKjump Free Fall Device always check:

- All anchor points have a minimum load capacity of 10kN (2248 lbs) and conform to all regional, local, federal and state requirement for such devices.
- The QUICKjump Free Fall Device will hang vertically over the line of descent with the nozzle pointing down.
- All paths that can be used by the rider when connected to the QUICKjump Free Fall Device are free of sharp edges and high friction surfaces that may damage the webbing line.

- Ensure that the descent path and landing area are free of other riders, pedestrians or obstacles that may cause entanglement or restrict the rider's descent.
- Choose a location that has a non-trafficked landing area below, without obstructions that would interfere with free and clear descent of rider.
- Ensure that the rider's line of descent has full clearance from obstacles within its fully extended range and is free to swing in all directions when in use. Any areas that may come into contact with the rider must be padded or protected.
- Install the device at the top of a structure where it can be safely reached for inspections and servicing.
- Always mount this device vertically overhead, so that the webbing line extends and retracts in a way that minimizes dangerous pendulum swings.



SAFE LANDING AREA

A protective fall attenuation surface must be used and centered below the landing point of the device, extending as required to adequately protect participants from injuries. It is recommended the surface meet ASTM F1292 specification for Impact Attenuation of Surfacing Materials for a critical fall height of 3ft (1m). A larger surface may be required in windy conditions.

OUTDOOR INSTALLATIONS

The QUICKjump Free Fall Device may be installed outdoors.

It is recommended that in wet or aggressive environments the QUICKjump Free Fall Device is protected from the direct ingress of water or foreign objects.



NOTE

Prolonged exposure to the elements will increase the risk of internal corrosion and degradation of the webbing line resulting in increased operation and servicing costs.



Use caution when operating the device in wind at speeds greater than 15 m/s (34 mph). High wind speeds can affect the downward path of the rider.

Mounting

With a suitable location for the QUICKjump Free Fall Device selected the device must be mounted only using the methods and hardware described in this manual. When mounting the QUICKjump Free Fall Device be aware of the following precautions:

- Anchor points must be capable of withstanding a minimum load of 10kN (2248 lbs) in expected direction of load application.
- All connectors, hooks, D-rings and shackles used to mount the QUICKjump Free Fall Device must meet a minimum breaking load of 10kN (2248 lbs) and comply with all relevant standards.
- All secondary connectors must be of compatible size, shape and strength to the mounting point to which they are attached.
- The QUICKjump Free Fall Device is free to pivot in all directions and should not bind the mountings or be able to impact upon the surrounding structure.

MOUNTING POINTS



USE ONLY THE DESIGNATED MOUNTING POINTS

Use only the correct mounting points designated for single or double point mounting. Use of incorrect points can result in equipment damage.

Ensure all mounting hardware is secure but free to pivot in mounting point.

The QUICKjump Free Fall Device is manufactured with a single central pivot mounting point, an offset mounting point and a formed handle located at the top of the casing. These mounting points are located on the central plate and are located to ensure the unit hangs centrally and vertically with the webbing line nozzle pointing down.



MOUNTING HEIGHT

When device is mounted, the distance between the nozzle height and platform height must be between 1.8 m (6 ft) and 2.1 m (7 ft).

A minimum distance of 1 m (3 ft) must be maintained between the QUICKjump Free Fall Device and any adjacent structure.

The Side Covers are a sacrificial protective cover designed to prevent damage to both the device and any adjacent surface. Should the covers become excessively worn, damaged, or aesthetically displeasing, they should be replaced by the Operator. Details of replacement parts may be found in the Spare Parts & Accessories section of this manual.

SINGLE POINT MOUNTING

Single point mounting is the preferred method of mounting your QUICKjump Free Fall Device to maximize webbing life. For single point mounting, the QUICKjump Free Fall Device is installed using the central mounting point, as

shown, with a longer non-loaded secondary mount utilizing the offset mount or handle mounting points.

For Single Point mounting use only the central mounting point as shown. Ensure mounting hardware is secure and the unit is free to pivot in all directions.

DOUBLE POINT MOUNTING

For Double Point mounting use only the Offset mounting point and Handle as shown. Ensure mounting hardware is secure but free to pivot around the mounting point.



NOTE

When Double Point mounting as shown, ensure that the attachments are equalized so that the load is shared equally between the anchor points and the QUICKjump Free Fall Device hangs vertically and is symmetrical about its center.

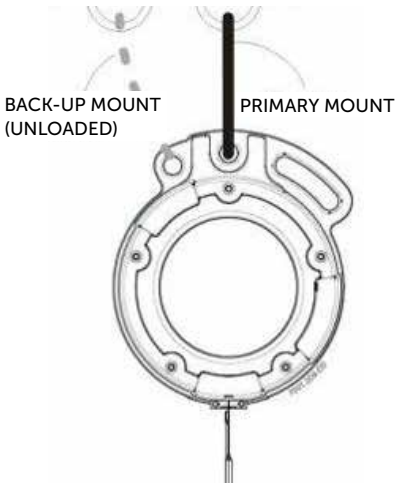

Single Point

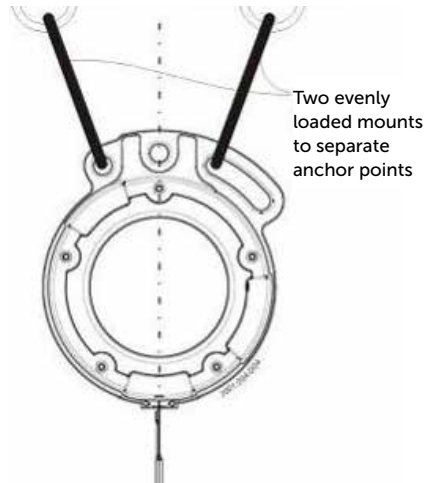

Double Point

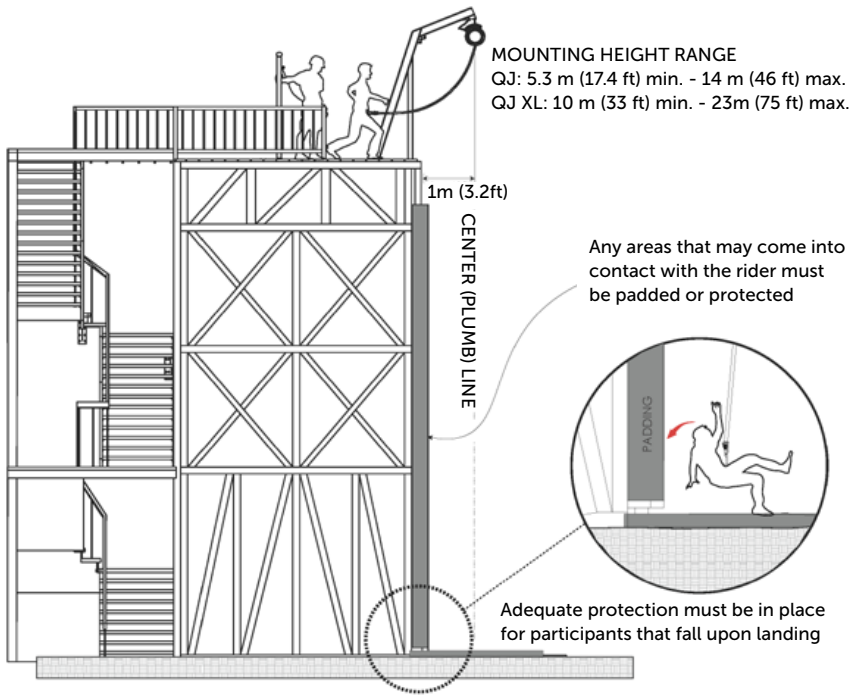

OPERATION

Owners and Operators of the QUICKjump Free Fall Device are responsible for the safety and supervision of any person using this equipment and are required by the manufacturer to read, understand and follow all instructions in this Operator Manual regarding the correct installation and operation of the QUICKjump Free Fall Device prior to any use.



UNSAFE OPERATION

Remove QUICKjump Free Fall Device from service immediately if there is any concern over its correct operation or user safety.

Do not return QUICKjump Free Fall Device to service until it has been inspected and completed a recertification inspection and test by an approved Head Rush Technologies Service Agent

Operator Training

All personnel involved in the operation of the QUICKjump Free Fall Device must be trained and deemed competent in the following aspects of QUICKjump Free Fall Device operation:

- Transportation and storage.
- Installation, use of attachment points and attachment methods and hardware.
- Rider requirements and instruction.
- Personal safety while assisting riders during operations or during required inspections and/or servicing and maintenance of equipment.
- Inspection, cleaning, and scheduled servicing of the QUICKjump Free Fall Device, its component parts and associated attachment hardware.

Operator must be present during operation.

Operator/User Instruction



NEVER DESCEND WITHOUT BEING CORRECTLY ATTACHED

Ensure carabiner is attached to designated attachment point of the harness, the latch is fully closed and the gate engaged before use.

Failure to do so can result in serious injury or death.



RIDERS MUST MEET CRITERIA FOR USE

The QUICKjump Free Fall Device should not be used by anyone that is/has:

- Weight over 130kg (285lbs)
- Weight under 20kg (44lbs)
- Pregnant
- Any type of heart condition or heart-related issues
- Any type of spinal injury or weak spine condition
- A weak physical constitution or poor physical conditioning

If you have any physical or medical conditions that may affect your ability to ride consult a medical professional prior to participation.

Prior to clipping in, all riders must be instructed in the proper and correct use of the QUICKjump Free Fall Device. Operators are to ensure all riders are familiar with the site rescue plan in the event the rider becomes distressed.

Prior to riding, the user and operator must be aware of, completely understand, and obey the following precautions:

- Never exceed the weight range of the device.
 - Only to be used by one person at a time.
 - Ensure that operators are anchored to the platform at all times. Riders must be anchored to the platform **AND** attached to the QUICKjump **UNTIL THEY ARE READY** to descend.
 - Visually inspect the webbing line, carabiner and the device to ensure that everything is in proper working order.
 - Never continue operation if the webbing line fails to fully retract. DO NOT pull out any excess webbing line prior to descent. The webbing line must be fully retracted or under tension prior to operation.
 - Check the harness is correctly fitted and tightened.
 - Check that the carabiner from the QUICKjump Free Fall Device line are connected to the designated attachment point(s) on the harness and the gate are properly closed.
-



PINCH HAZARD

Keeps fingers clear of carabiner and harness attachment point when descending. Loading may cause pinch.

- Ensure the carabiner latch gate is facing away from the rider and fully closed and locked.
- Never permit the webbing line to wrap around the legs, arms, neck, other body parts or loose clothing of the rider.
- Never descend from alongside or above the QUICKjump Free Fall Device.
- Prior to descent, ensure descent path and landing area are free of people and obstructions.
- When ready to descend, step straight down off platform.
- Always descend feet first and straight down using feet to fend off obstacles and prepare for landing.
- Upon landing, unclip the carabiner from the harness and allow the device to take up slack in the webbing and create tension before releasing the webbing line to be retracted freely and fully back into the QUICK-jump Freefall Device.

Harness



USE AN APPROVED HARNESS

Always use a harness complying with the standards specified in this manual. Ensure the harness is appropriate for use, in serviceable condition and correctly fitted. Always follow the harness manufacturer's instructions for fitment, care and use.

Children under the age of 10 years must only use a full body harness.

Use of a helmet is strongly recommended.

Carabiner Use

One self-closing, self-locking carabiner is supplied as an integral part of the webbing line. The carabiner must be checked and be in serviceable condition before any use. Ensure the carabiner is only loaded along the vertical direction (i.e. not cross loaded).



NOTE

If the carabiner is damaged or unserviceable, only a double or triple locking carabiner may be used as a replacement carabiner

Do not load secondary attachment point.



An optional secondary attachment point is provided on the webbing line above the primary carabiner loop. The secondary attachment point can be used as shown by tying a sling through the secondary attachment point and attaching a second carabiner to the sling. The second carabiner must hang below the primary carabiner to ensure that the secondary attachment point is not loaded during normal operation.



OPERATION

The carabiner is opened by rotating the gate's collar and pushing the gate open towards the center of the carabiner.

- Attach the carabiner to the correct loop on the harness with the latch facing away from the user.
- Allow the latch to snap shut, ensuring the collar has rotated back and is locked. Ensure that no clothing, webbing or other objects are obstructing the gate or latch.
- Double check that the gate on the carabiner is secure.

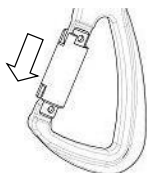

Step 1 – Slide



Step 2 - Twist

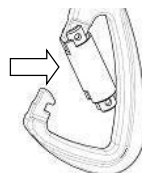

Step 3 – Depress



Step 4 – Release

Carabiner Operation

Webbing Retraction Procedure



RESETTING THE WEBBING STACK

If the webbing does not retract entirely into the device, the webbing stack may need to be reset.

TO RESET THE WEBBING STACK, fully extend the webbing and allow it to slowly retract while maintaining constant tension. This will ensure the stack lays flat inside the drum without any dead space. Do this any time poor retraction is suspected or incomplete retraction is noticed. Never manually feed webbing into the device.

If webbing still does not fully retract after (3) attempts of resetting the webbing stack, remove QUICKjump from service and contact Head Rush Technologies or your Head Rush Tech Distributor

WEBBING RETRACTION TIPS

Proper webbing retraction is crucial, especially when using the QUICKjump near its maximum operating height. Fully extending the QUICKjump webbing, then allowing it to freely retract without line tension, may cause improper webbing stacking, incomplete retraction, and accelerated webbing wear.

Always maintain tension on the line, especially after disconnecting a participant. This will ensure that webbing spools correctly inside the unit preventing voids or dead space from forming in the stack. Tension can be applied in three different ways:

1. An operator on the ground, after disconnecting a participant, can momentarily hold the line until the unit applies retraction tension. Then gently release the line to retract (using the weight of the RipCord/OPA assembly to maintain tension).
2. An operator adjacent to the device on the platform may gently hold the line to provide tension during retraction.
3. An operator on the ground may apply tension via a tag line attached to the end of the webbing for the first 3 m – 4.5 m (10 – 15 ft) of retraction so that the webbing is able to stack firmly and correctly.



ALWAYS FOLLOW CORRECT WEBBING RETRACTION PROCEDURE

Do not attempt to assist the retraction of the webbing for any reason. Doing so could lead to a dangerous binding of the webbing which can abruptly shorten the life of the webbing and cause significant drag in the system, accelerating webbing wear and roller contamination.

A loose webbing stack from incorrect webbing retraction procedures can cause inconsistent and undesirable braking and proportionately large load changes to the rider.

INSPECTION AND MAINTENANCE

Annual Recertification



DO NOT OPERATE AFTER THE DATE SHOWN ON THE CERTIFICATION LABEL

Operation of the QUICKjump Free Fall Device without a current Certification Label visible will render the unit not fit for use and void all warranty.

The QUICKjump Free Fall Device requires an annual service and recertification inspection to be carried out by an authorized Head Rush Technologies service agent.

The Certification expiration date is shown on the Certification Label located on the side of the front casing. Dismount the QUICKjump Free Fall Device and return to the Manufacturer at the address shown at the back of this Manual or to an Authorized Service Center prior to the expiration date.

head rush
technologies

SERIAL NUMBER: [input box]

MANUFACTURE DATE: [input box with slashes]

RECERTIFICATION DATE: [input box with slashes]

NEXT RECERT REQUIRED: [input box with slashes]

BY: [input box]

LABEL P/N: 00070002401

Do NOT use the QUICKjump Free Fall Device after date shown here.

Scheduled Maintenance and Inspections

The following inspection and service actions must be carried out by the operator or operator-trained staff. Inspection log forms can be found at headrushtech.com/service/inspection-logs. All personnel performing these actions must be trained in the correct procedures and deemed competent to do so.



INSPECTION AND MAINTENANCE REQUIRED

Failure to perform scheduled maintenance and inspections on the QUICKjump Free Fall Device may result in serious injury or death.



Ensure that service/inspection staff are adequately belayed during inspections. Failure to do so can result in serious injury or death.



NO UNAUTHORIZED SERVICING

Do not attempt to carry out any maintenance, repair or service actions not detailed in the User Manual.

Any unauthorized maintenance, repair or modifications to the QUICKjump Free Fall Device will compromise safety, render the unit not fit for use, and void the warranty provisions.



NOTE

Service in a clean environment. If QUICKjump Free Fall Device has been removed from its operational location for service, ensure that the service area is clean and free from contaminants.

Ensure unit is securely placed on a sturdy work table and plastic side covers are not subject to damage.

SAFETY PRECAUTIONS



HEAVY OBJECT

Ensure the QUICKjump Free Fall Device is secured during service to prevent accidental damage or injury from dropping.



CAUTION – SPRING LOADED PARTS

The webbing assembly is spring loaded and will rapidly return into the device if released. This may result in damage or injury.



MAGNETIC PARTS

The QUICKjump Free Fall Device contains strong magnets. Always ensure working environment is free of loose ferrous materials. Ingress of metal objects may compromise belay operation.

Daily Inspection

The QUICKjump Free Fall Device must be inspected daily for correct operation and overall condition. The daily inspection may be carried out with the unit in place or removed to a sturdy work table.

INSPECTION PROCEDURE

Ensure adequate lighting and unrestricted access are available to permit a thorough inspection of all areas of the QUICKjump Free Fall Device. This inspection should be completed either with the QUICKjump Free Fall Device dismounted or by climbing to the location of the QUICKjump Free Fall Device and anchoring in, so you may visually inspect the unit and the entire length of webbing.

1. Clean any dust, dirt or contamination off the casing and fittings with a clean cloth.



DO NOT USE SOLVENTS OR ABRASIVES

Clean with a cloth only. Do not use any cleaners, solvents or abrasives on any part of the QUICKjump Free Fall Device or its associated equipment.

2. Visually inspect the casing, mounting holes and plastic covers for wear, impact damage, cracking, deformation and corrosion. Replace any damaged items or remove QUICKjump Free Fall Device from service.
3. Check that all safety labels are in place and in good condition.
4. Check that date on Certification Label is current.
5. Inspect the condition of the carabiner, checking for:
 - Wear and damage.
 - Correct operation of the locking mechanism.
 - If the carabiner gate does not automatically lock, clean and brush, lubricate with dry graphite or wax based lubricant only until fully operational. If full functionality cannot be restored, replace carabiner.
6. QUICKjump and QUICKjump XL ONLY: Inspect the entire exterior condition of the Overload Protection Assembly (OPA) checking that:
 - Assembly is contained within the jacket.
 - No excess threads are visible.
 - OPA has not deployed.
 - Ensure the black strip and stitching remains intact. Rupture of this component may indicate an overload event.



ACTIVATION STRIP

7. Slowly pull out the entire length of webbing from the unit. As webbing is withdrawn inspect for:
 - Damage, cuts or abrasion to stitching.
 - Cutting, wear and abrasion to the surface or edge of webbing.
 - Discoloration, fading or chalking of the surface.
 - Heat and friction damage such as hard or shiny areas.
 - Contamination from dirt or chemicals.
 - Twisting or knotting.

Replace webbing if any signs of wear or damage are present.

8. Allow the webbing to slowly retract into the casing while applying tension – checking that the retraction action is strong and smooth. Ensure that the webbing line is fully retracted.
9. Ensure that side covers are in place.
10. Complete and file the daily portion of the “Daily & Weekly Device Inspection Log”.
11. Return QUICKjump Free Fall Device to service.

RIPCORD INSPECTION

The RipCord should be inspected daily along with the device and webbing inspections.

1. Start where the RipCord meets the OPA, looking for excess wear, loose threads, or damage.
2. Move up the RipCord, inspecting the full outer webbing for defects, including tears, UV damage such as discolored, brittle or stiff webbing, cuts, visible abrasion damage, torn sewing joints or other defects.
3. Ask a partner to help, and pull the RipCord tight. Check that the outer webbing remains slack while the internal webbing is tight. If the outer webbing pulls tight, replace the RipCord immediately.
4. Finally, inspect where the RipCord meets the device webbing, and look for excess wear, loose threads, or damage. If any damage or defect is found, the webbing line must be replaced immediately.



FAILURE TO MAKE DAILY INSPECTIONS AND/OR REPLACE THE COMPLETE WEBBING WHEN ANY SIGNS OF WEAR ARE PRESENT MAY RESULT IN SERIOUS INJURY OR DEATH OF A PARTICIPANT.

Any indication of the webbing or unit being out of specification mandates the immediate removal of the webbing or device from service.

WEBBING WEAR













INSPECT WEBBING DAILY

Webbing in your QUICKjump must be evaluated on a daily basis. A detailed description of when a webbing should be taken out of service is included in the Failure Table below. **Webbing MUST be taken out of service by the time the webbing resembles the stage of wear designated in the Failure Table.** Continued use of webbing with wear at or beyond the designated stage of wear below may result in serious injury or death.

WEAR TABLES

Webbing pictures outlined in **red** in the tables below show webbing that **MUST** be taken out of service and replaced immediately to continue using your QUICKjump. The **green** outlined photos show webbing that can be kept in operation.

QUICKjump		
Degree of Wear	Side Wear	Face Wear
NEW		
STAGE 1		
STAGE 2		
STAGE 3		
STAGE 4		











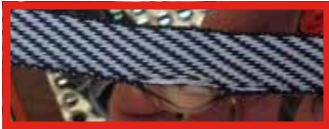

MOLDY WEBBING

Any webbing showing signs of mold should be taken out of service.

Table 1: QUICKjump Side & Face Wear

WEAR TABLES

Webbing pictures outlined in **red** in the tables below show webbing that **MUST** be taken out of service and replaced immediately to continue using your QUICKjump. The **green** outlined photos show webbing that can be kept in operation.

QUICKjump XL		
Degree of Wear	Side Wear	Face Wear
NEW		
STAGE 1		
STAGE 2		
STAGE 3		
STAGE 4		
STAGE 5		

MOLDY WEBBING

Any webbing showing signs of mold should be taken out of service.

Table 2: QUICKjump XL Side & Face Wear

WEAR TABLES

Webbing pictures outlined in **red** in the tables below show webbing that **MUST** be taken out of service and replaced immediately to continue using your QUICKjump. The **green** outlined photos show webbing that can be kept in operation.



Degree of Wear	UV Damage
NEW	
STAGE 1	
STAGE 2	

Table 3: UV Damage

TROUBLESHOOTING WEBBING WEAR

Symptoms	Potential Causes	Potential Solutions
WEBBING FACE WEAR SIDE WEAR & LOOP FAILURE	Participants are swinging excessively as they descend	Encourage participants to step off the platform rather than jumping out. Participants should also jump vertically. Flailing motions (swinging arms and legs, leaning forward/back, etc.) acts like pumping on a swing and can create more lateral movement.
	Foreign objects, including dirt and/or dust have introduced damage to nozzle stainless steel surface	Inspect nozzle for burrs and other damage. If damage is found, replace nozzle.
	QUICKjump is mounted incorrectly.	Ensure that the QUICKjump is mounted according to Operator Manual, whether single or dual mounting. Make sure that the QUICKjump is not angled. Always mount QUICKjump vertically with nozzle pointed down.
	Foreign objects, including dirt and/or dust have introduced damage to webbing assembly	Cover the QUICKjump when not in use. Wipe the webbing with a dry cloth daily, after use.
	Webbing is rubbing on obstruction	Move the obstruction so that it does not interfere with QUICKjump operation.
	Normal use of QUICKjump	Parts and webbing wear over time with normal operation, replace webbing as necessary.
UV FADED WEBBING	Sun is damaging webbing	Remove QUICKjump at the end of day or cover unit and webbing after use.
JACKET DAMAGE	Participants are pulling down on QUICKjump jacket as they jump	Coach participants to hold jacket up and away from face. Holding jacket down then jumping puts excess wear on jacket when webbing is tensioned and jerked upward.
WEBBING IS MOLDY/ DISCOLORED	Webbing is not being dried after being used in wet conditions	Whenever using the QUICKjump in wet conditions, take the unit down at the end of the day, extend the webbing in a sanitary environment, and allow webbing to dry outside of the unit. Do not store in wet condition.

Weekly Inspection

In addition to the daily inspection above, the following inspection procedures must be carried out on a weekly basis for the QUICKjump and QUICKjump XL.

1. Inspect the interior condition of the Overload Protection Assembly (OPA).
 - Open the jacket and inspect the entire assembly checking that no threads are broken and that the webbing is in good condition. If any broken threads are found, the webbing line must be replaced immediately. See Daily Inspection for additional OPA inspection guidelines.
2. Complete and file the weekly portion of the "Daily & Weekly Device Inspection Log".

Six Month Inspection

The QUICKjump Free Fall Device requires an in depth six (6) month inspection by the Operator to maintain its safe and efficient operation. For the six month inspections, the unit must be dismantled and removed to a sturdy work table.

INSPECTION PROCEDURE

1. Dismount the QUICKjump Free Fall Device (refer to Installation Instructions)
2. Clean QUICKjump Free Fall Device using a clean cloth.
3. Carry out Steps 1 through 6 of the "Daily Inspection".
4. Remove the nozzle – Refer to "Nozzle Replacement" for removal procedure.
5. Inspect nozzle assembly for the following:
 - Excessive wear to slot.
 - Splitting, cracking and deformation
 - Correct fitment in housing.

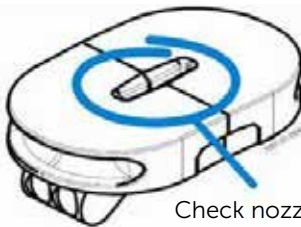

Check nozzle for excessive wear around slot

Nozzle Wear

WEBBING INSPECTION

1. With the nozzle assembly removed, pull out the complete webbing line, including approx. 100 mm (4 in) of the drum lead. See “Nozzle Replacement” for removal procedure.
 - Place a line holding pin through the loop in the drum lead, above the joining link to prevent it retracting back into the unit.
2. Inspect both the upper (drum) webbing and the webbing line by passing the webbing slowly through your hands under a good light. Inspect the webbing for:
 - Damage to stitching (cuts or abrasion).
 - Cuts to webbing, especially to edges.
 - Abrasion across the surface of the webbing, wear and fraying, especially to the edges and the webbing loops.
 - UV degradation – although difficult to detect, visual indications are discoloration, fading and chalking of the webbing surface.
 - Chemical attack, this can result in soft or weak fibers, color change or flaking of the surface.
 - Heat or friction damage, indicated by hard fibers or glazing of the surface.
 - Contamination from dirt, grit, sand or rust.
 - Twisting, knotting or permanent deformation of webbingReplace the webbing if any signs of damage or deterioration are present
3. Inspect the webbing joining shackle. Ensuring that:
 - The shackle pin is secure and straight – do not attempt to tighten.



NOTE

The shackle pin is secured with thread locking compound and any attempt to turn will compromise its security.

- The shackle is undamaged and in the correct orientation.
- The webbing around the link is not worn or damaged.



Webbing Line Holding Pin

4. Remove the line holding pin and allow the upper line to slowly retract into the casing. Inspect the webbing as it retracts and ensure that the webbing line does not twist.
5. Refit the nozzle assembly.
6. Complete and file the “Biannual Device Inspection Log”.
7. Return QUICKjump Free Fall Device to service.

Nozzle Replacement

If the nozzle assembly shows signs of excessive wear, damage or poor fit it must be replaced.



USE ONLY GENUINE HEAD RUSH TECHNOLOGIES REPLACEMENT PARTS



ALWAYS REPLACE NOZZLE AS A PAIR

If nozzle requires replacement always replace as a matched pair – Do not mix worn and new nozzle pieces.

To remove the nozzle assembly:

1. Place the QUICKjump Free Fall Device unit side cover down taking care not to damage the plastic side covers - Ensure device is secure and cannot fall.
2. Pull out the nozzle pin.
3. Hold on to the lower line to keep it from retracting and lift out the two half sections of the nozzle.
4. Fit a suitable pin in the loop of the webbing line to prevent it retracting back into the casing.



Assembled nozzle

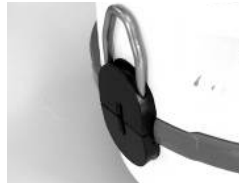

Step 1 - Remove pin



Step 2 - Lift out top half



Step 3 - Remove lower half

NOTE: Webbing line not shown

To refit the nozzle assembly:

1. Refit the lower half of the nozzle assembly into the recess on the casing.
2. Fit the upper half of the nozzle assembly.
3. Remove webbing pin and allow the webbing to slowly rewind into the casing until fully retracted.
4. Check QUICKjump Free Fall Device for correct operation.



Step 1 - Fit top half



Step 2 - Fit bottom half



Step 3 - Fit pin



Assembled nozzle

NOTE: Webbing line not shown

Webbing Line Replacement

If the lower webbing line shows signs of wear, damage or contamination then it will need to be replaced. Replace webbing line as follows:

SAFETY PRECAUTIONS



DO NOT ALLOW WEBBING LINE OR DRUM LEAD TO RETRACT INTO HOUSING

With nozzle removed take care not to permit uncontrolled retraction of drum lead or webbing line into casing. Uncontrolled retraction will result in internal damage and require repair by the manufacturer.



USE ONLY GENUINE HEAD RUSH TECHNOLOGIES REPLACEMENT PARTS

WEBBING LINE REPLACEMENT PROCEDURE

To replace the webbing line:

1. Remove the QUICKjump Free Fall Device from service and place securely on the work bench.
2. Remove the Nozzle assembly – Refer to 'Remove Nozzle Assembly'.
3. While holding QUICKjump Free Fall Device securely, pull out the webbing line until the end of the drum lead and the joining shackle are exposed.
4. Locate the loop in the drum lead, approx. 100 mm (4 in) past the link - Place a suitable line holder pin through the loop in the drum lead to prevent it retracting back inside the casing.

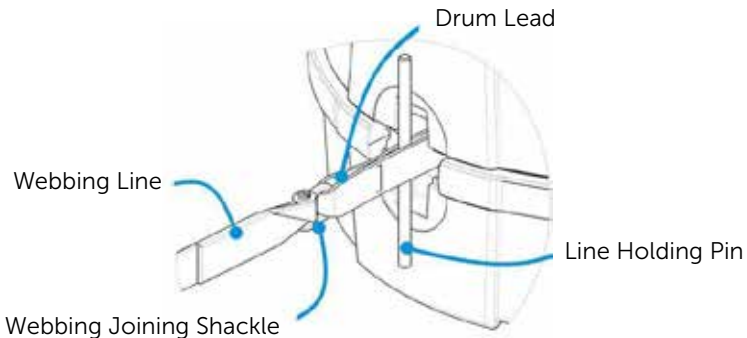

Webbing joining link parts

5. Unscrew the shackle pin.
6. Remove webbing line and complete shackle assembly from the drum lead.
7. Fit new shackle supplied with the line – Ensure the loop part of the shackle is fitted to the drum lead.



THREAD LOCKING COMPOUND ON REPLACEMENT SHACKLE PIN

Once the shackle pin is removed from the shackle assembly, it cannot be reused. Ensure the factory applied thread locking compound is present on the replacement shackle pin threads.

8. Fit the new webbing line, passing the threaded shackle pin through the loop as shown.

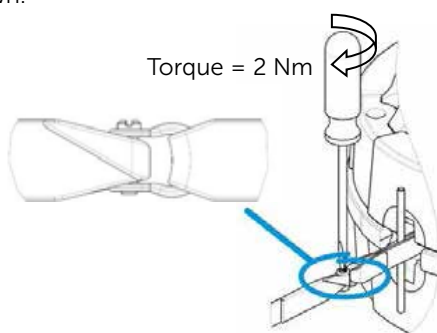

Correct shackle fitment

9. Tighten the shackle pin to 2 Nm (18 lb-in), ensuring the threads are fully engaged and the end of the pin is flush with the joining shackle as shown.
10. Remove the line holding pin and allow the new webbing line to slowly retract until drum lead and joining link is inside casing. Ensuring that the webbing line does not twist.



Once shackle pin is tightened, it must not be loosened or re-tightened. This will break the locking compound and the shackle pin may become loose. The shackle pin must be replaced if this happens.



Ensure that the webbing line feeds squarely and without twists when retracting back into the QUICKjump Free Fall Device.

Failure to do so may result in equipment failure, serious injury or death to participants.

11. Refit nozzle assembly – Refer 'Refit Nozzle Assembly'.
12. Slowly retract the webbing line into the casing, checking the action is smooth and adequate spring resistance is felt.
13. Once webbing line is fully retracted, pull out webbing line a short distance using reasonable force and allow it to retract. Repeat two to three times to ensure webbing line is firmly wound onto the drum.
14. Return QUICKjump Free Fall Device to service and check for correct operation.

Replacement Parts

Your QUICKjump Free Fall Device is fitted with a number of user replaceable parts that may be refitted without the need to return the device to an authorized Head Rush Technologies service agent. Always follow the manufacturer's instructions as detailed in the User Manual and any Part Replacement Guide supplied when undertaking replacement of a part.



NOTE

For optimal performance of your QUICKjump Free Fall Device, only use genuine Head Rush Technologies spare parts and accessories.

When ordering replacement parts, please specify the part number and description of the part.

DESCRIPTION	PART NUMBER
Replacement Webbing Kit	
QUICKjump	02050008601
QUICKjump with 0.8m Low Mount RipCord	02005115902
QUICKjump with 1.5m RipCord	02050008101
QUICKjump XL	02150008501
QUICKjump XL with 1.5m RipCord	02150008201
QUICKjump XL with 3m RipCord	02150008301
Nozzle Replacement Kit	
QUICKjump	00060055101
QUICKjump XL	01160008801

Side Cover (with Label)

QUICKjump	02060028601
QUICKjump XL	02160055201

To order replacement parts or accessories, contact your authorized Head Rush Technologies Distributor, Service Center, or go to <https://store.headrushtech.com>.

Troubleshooting

Refer to the online troubleshooting section at www.headrushtech.com for up-to-date troubleshooting instructions or contact your authorized Head Rush Technologies Distributor or Service Center.

Transportation

To ensure the safe shipment of your QUICKjump Free Fall Device, it should only be shipped in authorized Head Rush Technologies packaging (box and packing material). If you have misplaced your original packaging, purchase replacement packaging from an authorized QUICKjump Free Fall Device Service Center, or online at www.headrushtech.com. You will be responsible for the cost of any damage and necessary repairs due to shipping your QUICKjump Free Fall Device in unauthorized packaging.

**CARE FOR THE ENVIRONMENT**

Reuse the original packaging when shipping Free Fall Device.

MANUFACTURER'S DETAILS

Return the QUICKjump Free Fall Device to the Manufacturer at the address shown below for any recertification or unscheduled service or repairs.

ADDRESS

Head Rush Technologies
1835 38th Street, Suite C
Boulder, CO 80301
USA

CONTACT DETAILS

+1-720-565-6885
www.headrushtech.com
info@headrushtech.com



REGISTER YOUR DEVICE

Get automatic updates on recertification and product information – visit [*headrushtech.com/register*](https://headrushtech.com/register)

ANNUAL RECERTIFICATION IS REQUIRED

Please keep the shipping box for your device. For instructions on annual recertification, visit [*headrushtech.com/recertification*](https://headrushtech.com/recertification)

+1-720-565-6885

headrushtech.com

info@headrushtech.com

Jul 2017